

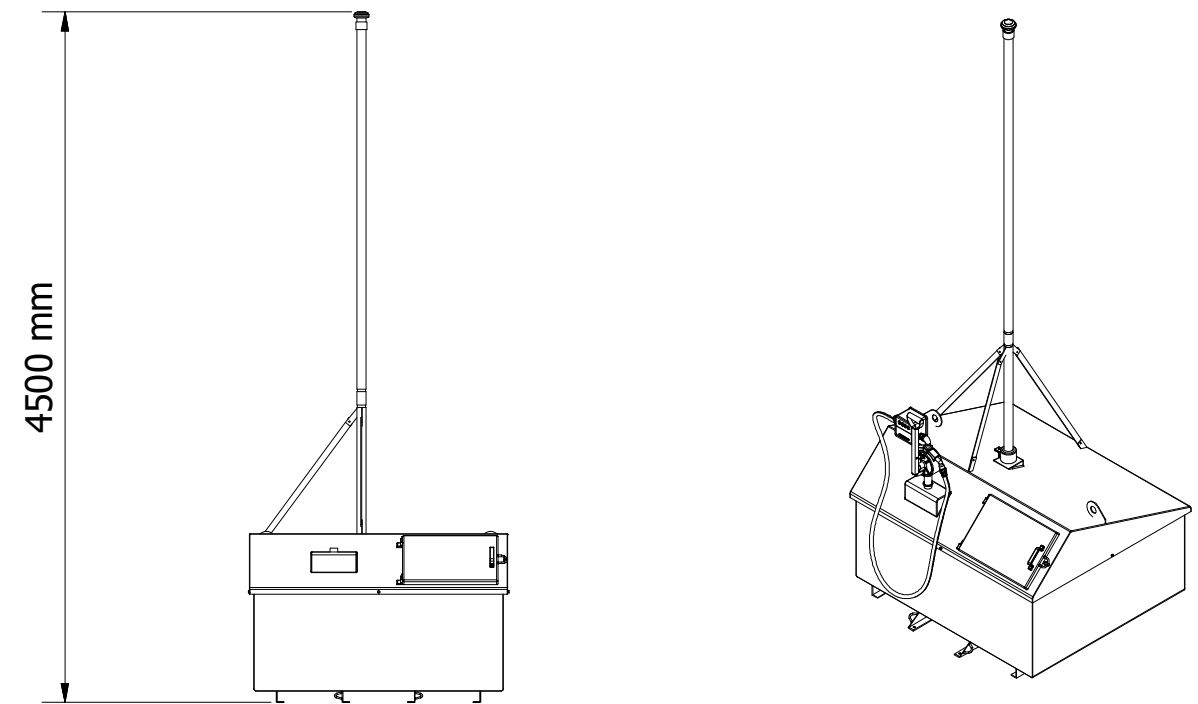

1250 PT

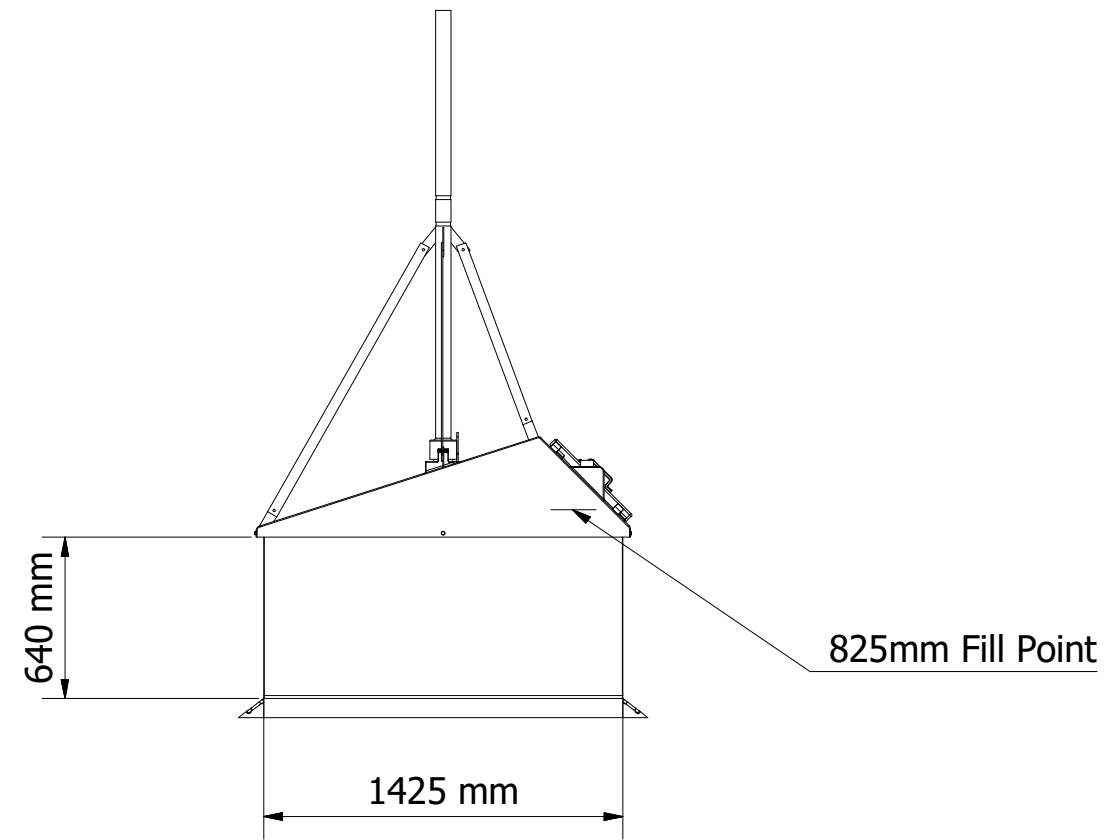
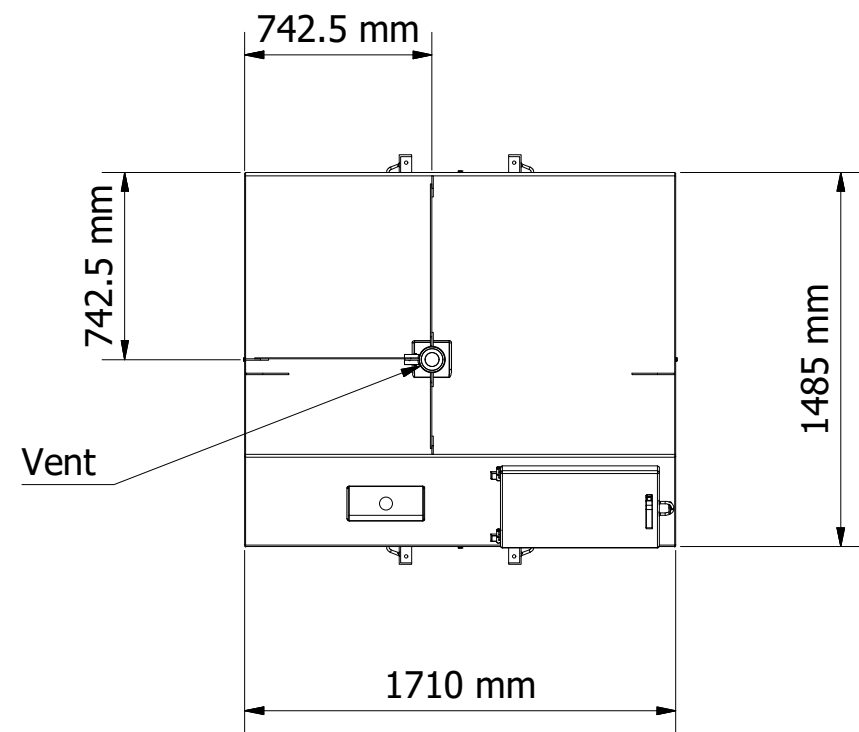
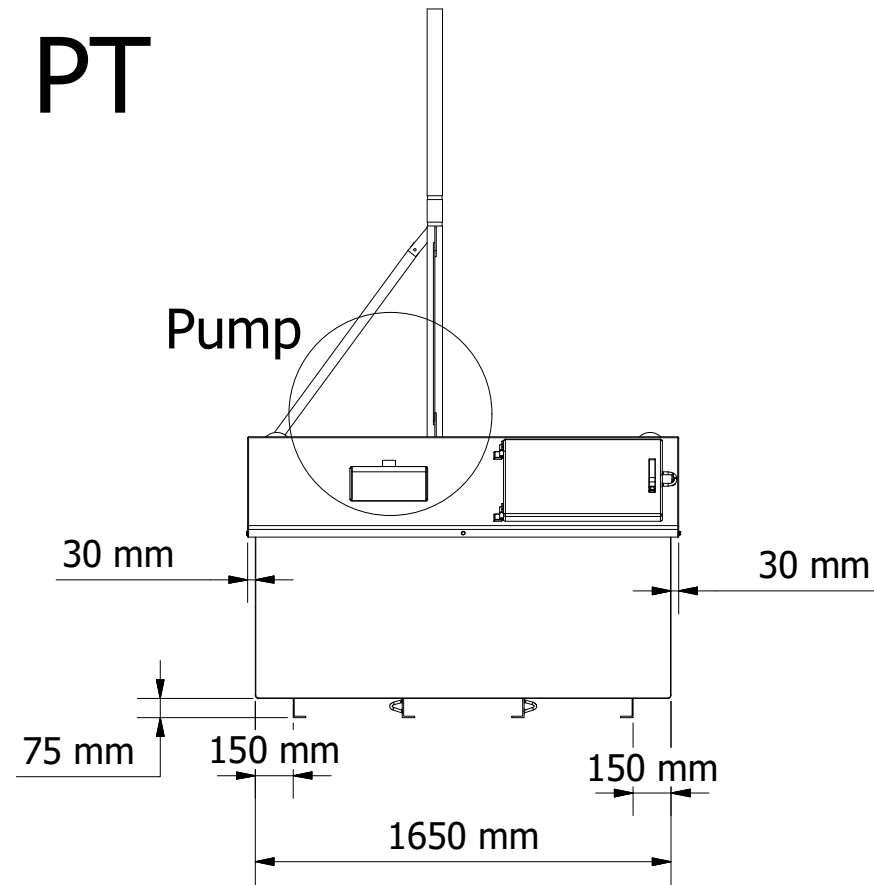

DESIGNED BY Rob Smith	CHECKED BY J Shenton	APPROVED BY	DATE	DATE 08/03/2018
			1250 PT	
			Weight - 795 Kgs	ISSUE A