

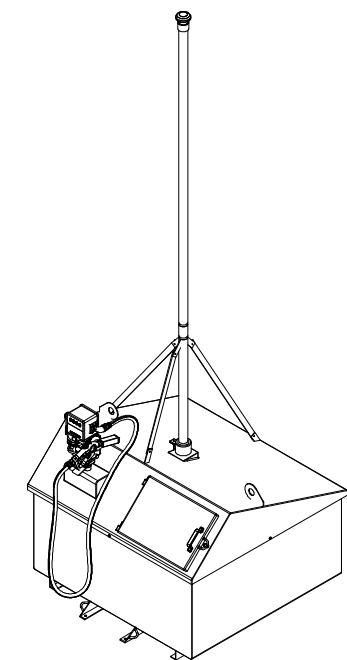

975 PT

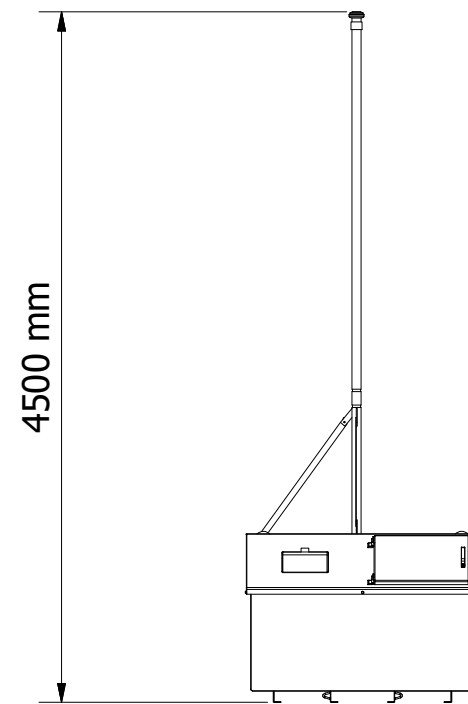
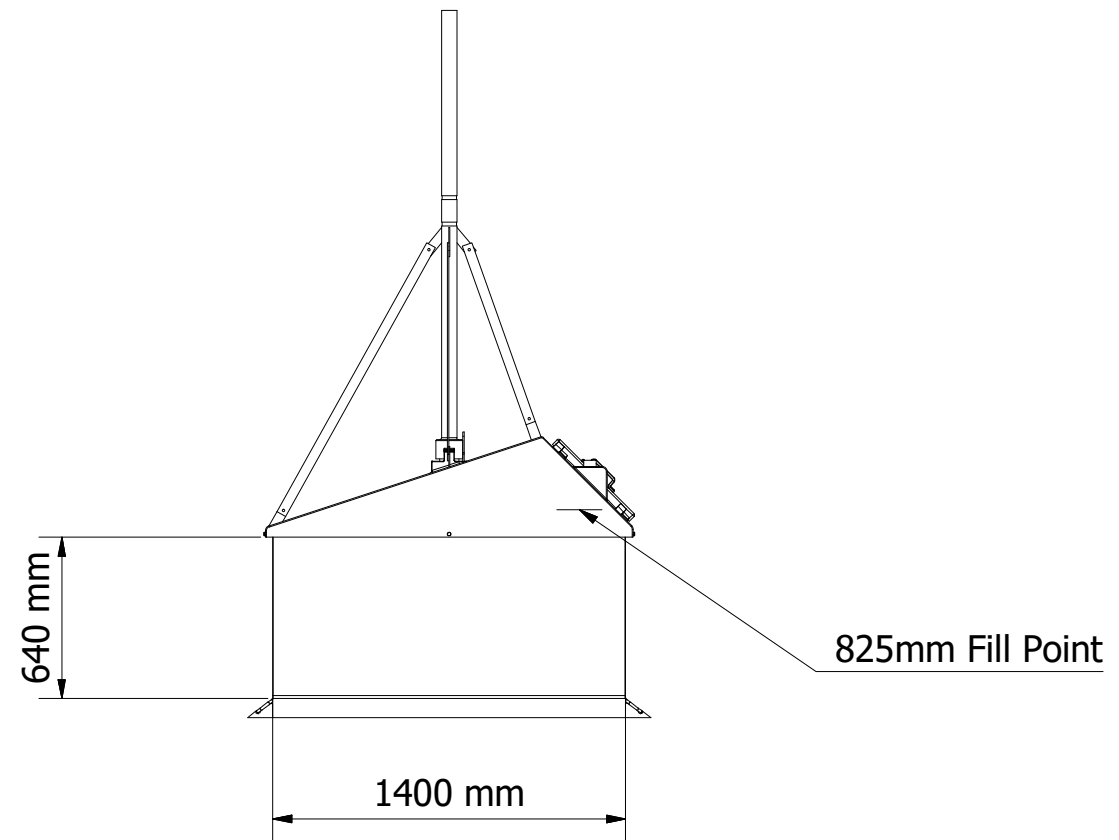
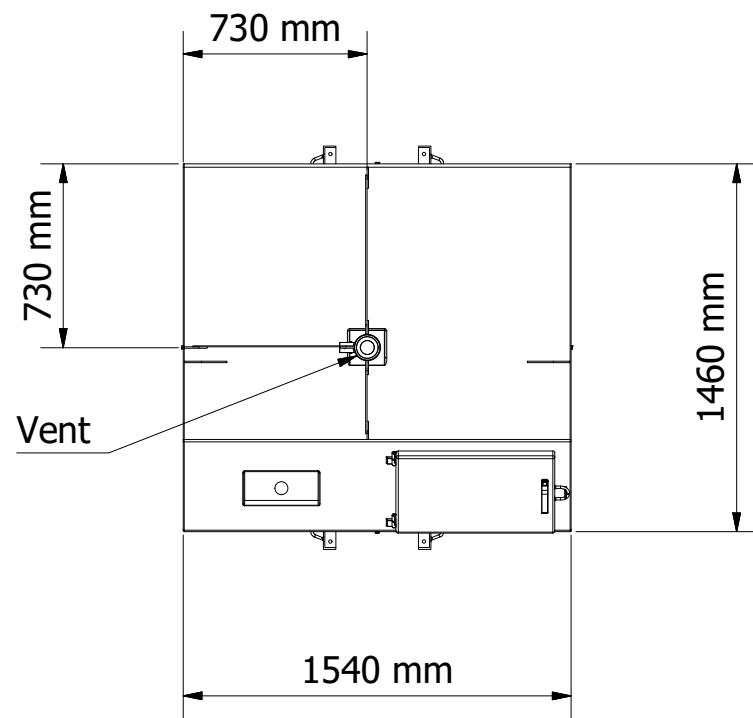
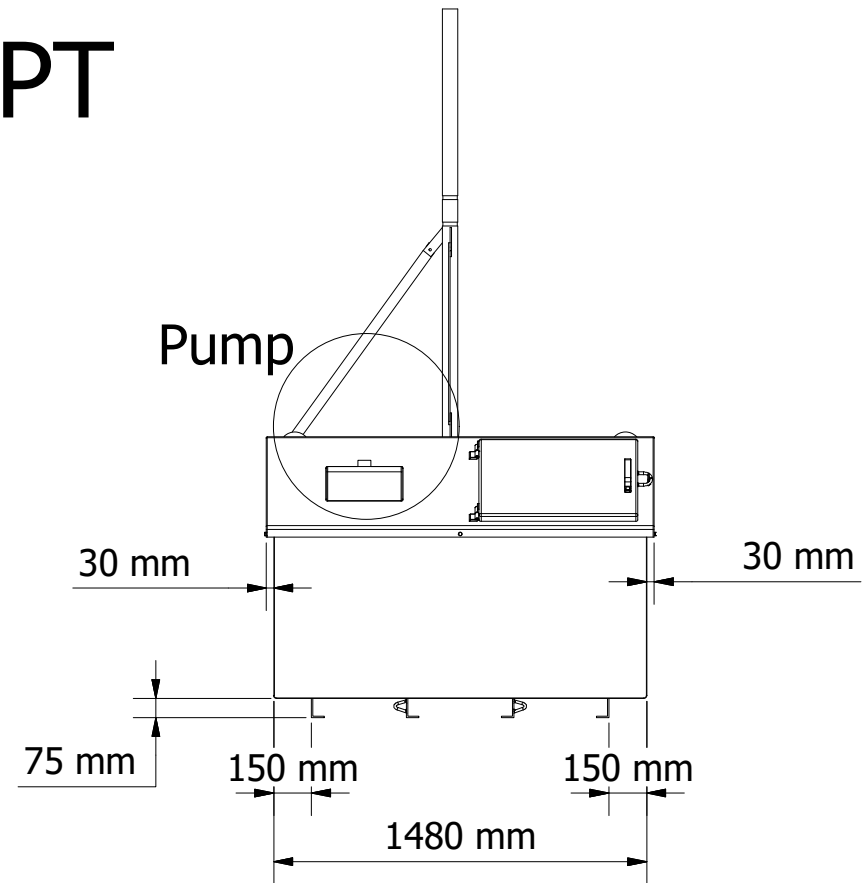

DESIGNED BY Rob Smith	CHECKED BY J Shenton	APPROVED BY	DATE	DATE 08/03/2018
		975 PT		
		Weight - 585 Kgs	ISSUE A	SHEET 1 / 1